

### Product Description

The BSW6420 is an absorptive SPDT 50Ω matched RF switch supporting bandwidths up to 6GHz. Its high linearity performance across the temperature range makes it ideally suited for use in 3G/4G/5G wireless infrastructure and 802.11 a/n/ac/ax applications where high power and excellent performance is required.

The BSW6420 is designed with robust ESD protection circuits at all pins and packaged in an industry standard, fully RoHS2-compliant, 16-Lead, 3mm x 3mm x 0.75mm TQFN package.

The BSW6420 does not require blocking capacitors. If DC is presented at the RF port, add a blocking capacitor.

A functional block diagram is shown in Figure 1.

### Block Diagram

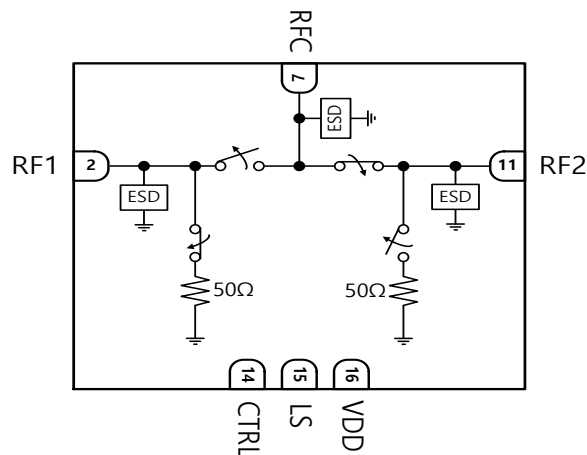

Figure 1 Functional Block Diagram

### Applications

- Wireless 3G/4G/5G Infrastructure
- WLAN 802.11 a/n/ac/ax

### Package Type



3mm x 3mm x 0.75mm, 16-Lead TQFN Package

Figure 2 Package Type

### Device Features

- Output frequency range : 50 MHz to 6.0 GHz
- Supply Voltage : 2.7V to 3.6V
- ESD, HBM
  - : 2.5kV @ RF pins
  - : 2.0kV @ All pins except RF pins
- Constant impedance during switching transition
  - : Return loss 10dB
- Operating temperature range : -40°C to +105°C
- Low Insertion Loss
  - : 0.79dB @ 2.35GHz
  - : 0.81dB @ 3.5GHz
  - : 0.84dB @ 4.9GHz
- High Isolation
  - RFC to RFx
    - : 66dB @ 2.35GHz
    - : 56dB @ 3.5GHz
    - : 48dB @ 4.9GHz
  - RFx to RFx
    - : 52dB @ 2.35GHz
    - : 47dB @ 3.5GHz
    - : 42dB @ 4.9GHz
- High Input 1dB Compression
  - : 40.5dBm @ 2.35GHz
  - : 41dBm @ 3.5GHz
  - : 41dBm @ 4.9GHz
- High IIP3
  - : 63.5dBm @ 2.35GHz
  - : 66dBm @ 3.5GHz
  - : 66.5dBm @ 4.9GHz
- Switching Time : 530 to 540ns
- 16-Lead TQFN package : 3.0mm x 3.0mm x 0.75mm
- Lead-free/RoHS2-compliant TQFN SMT Package

**Electrical Specifications**

Typical conditions are at VDD = 3.3V, T<sub>A</sub> = 25°C, LS/CTRL Low = 0V, LS/CTRL High = 3.3V, Z<sub>L</sub> = 50Ω, Excluding SMA Connector and PCB loss<sup>(1)</sup>, unless otherwise noted.

**Table 1 Electrical Specifications**

Parameter	Path	Condition	Min	Typ	Max	Unit
Operating Frequency			50		6000	MHz
Insertion Loss	RFC - RFx	1GHz		0.70		dB
		2GHz		0.77		
		3GHz		0.82		
		4GHz		0.80		
		5GHz		0.84		
		6GHz		1.03		
Isolation	RFC - RFx	1GHz		69		dB
		2GHz		67		
		3GHz		61		
		4GHz		52		
		5GHz		48		
		6GHz		45		
Isolation	RFx - RFx	1GHz		62		dB
		2GHz		55		
		3GHz		49		
		4GHz		45		
		5GHz		41		
		6GHz		37		
Return Loss (Active Port)	RFC, RF1, RF2	50MHz – 6GHz		15		dB
Return Loss (Terminated Port)	RFC, RF1, RF2	50MHz – 6GHz		15		dB
Return Loss during switching transition	RFC, RF1, RF2	50MHz – 6GHz		10		dB
Input P1dB	RFC - RFx	2.35GHz		40.5		dBm
		3.5GHz		41.0		
		4.9GHz		41.0		
Input IP3 <sup>(2)</sup>	RFC - RFx	2.35GHz		63.5		dBm
		3.5GHz		66.0		
		4.9GHz		66.5		
Input IP2 <sup>(2)</sup>	RFC - RFx	2.35GHz		108		dBm
		3.5GHz		109		
		4.9GHz		110		
2 <sup>nd</sup> Harmonic <sup>(3)</sup>	RFC - RFx	2.35GHz		97		dBc
		3.5GHz		97		
		4.9GHz		100		
3 <sup>rd</sup> Harmonic <sup>(3)</sup>	RFC - RFx	2.35GHz		100		dBc
		3.5GHz		105		
		4.9GHz		105		
Switching Time	RFC - RFx	50% control to 90% RF		540		ns
		50% control to 10% RF		530		
Settling Time	RFC - RFx	50% CTRL to 0.05dB final value Rising Edge		560		ns
		50% CTRL to 0.05dB final value Falling Edge		550		

The typical spurious performance of the BSW6420 is -115dBm / 10Hz @ Over 10MHz

(1) Excluding SMA Connector and PCB loss.

(2) Tone Power is 18dBm and Tone spacing is 20KHz.

(3) Tone Power is 18dBm.

### Product Description

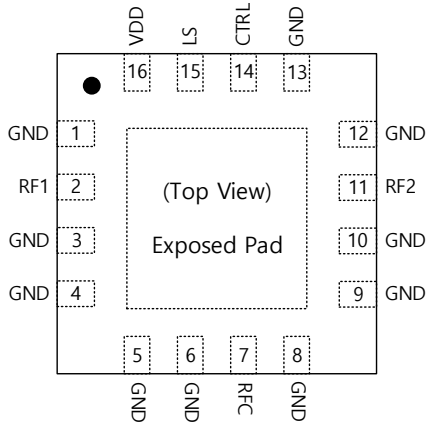

Figure 3 Pin Description

Table 2 Pin Descriptions

No.	Pin Name	Descriptions
2	RF1	RF1 Port
7	RFC	RF Common Port
11	RF2	RF2 Port
14	CTRL	Digital Control Logic Input
15	LS	Logic Select (Definition for the CTRL pin, See Table3)
16	VDD	Supply Voltage
1,3,4,5,6,8,9,10,12,13	GND	Ground
Pad	Exposed Pad	Ground

Table 3 Control Truth Table

LS	CTRL	RFC-RF1	RFC-RF2
0	0	OFF	ON
0	1	ON	OFF
1	0	ON	OFF
1	1	OFF	ON

Table 4 Operating Ranges\*

Parameter	Symbol	Min	Typ	Max	Unit
Supply Voltage	VDD	2.7	3.3	3.6	V
Supply Current	IDD	-	180	-	μA
Digital Input Control (LS/CTRL)	High	1.0	-	3.3	V
	Low	0	-	0.7	V
Operating Temperature Range	To	-40	+25	+105	°C
RF Input Power, CW (Active Port) 2.35GHz, 3.5GHz, 4.9GHz (any port)	P <sub>Max,Active</sub>	-	-	36	dBm
RF Input Power, CW (Terminated Port) 2.35GHz, 3.5GHz, 4.9GHz (RF1, RF2 port)	P <sub>Max,Term</sub>	-	-	26	dBm

\*Specifications are not guaranteed over all recommended operating conditions.

Table 5 Absolute Maximum Ratings

Parameter	Symbol	Min	Max	Unit	
Supply Voltage	VDD	-0.3	3.6	V	
Digital Input Voltage	LS/CTRL	-0.3	3.6	V	
Maximum Input Power, CW (+25°C)	-	-	Input P1dB	dBm	
Storage Temperature range	-	-65	+150	°C	
ESD	HBM	RF pins	-	2500	V
		All pins	-	2000	V
	CDM	All pins	-	1000	V

### Typical Performances

Typical conditions are at VDD = 3.3V, T<sub>A</sub> = 25°C, LS/CTRL Low = 0V, LS/CTRL High = 3.3V, Z<sub>L</sub> = 50Ω, Excluding SMA Connector and PCB loss, unless otherwise noted.

**Figure 4 Insertion Loss vs VDD (RFC - RF1)**

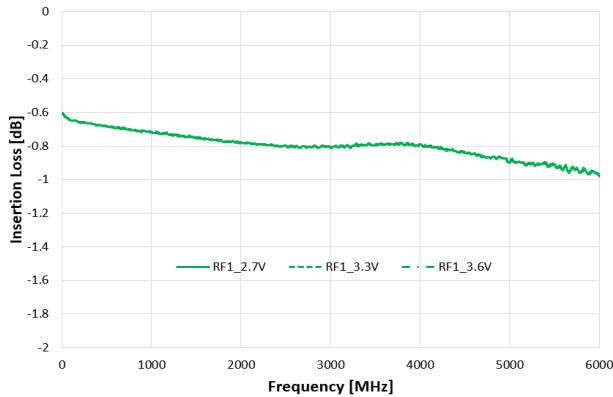

**Figure 5 Insertion Loss vs VDD (RFC - RF2)**

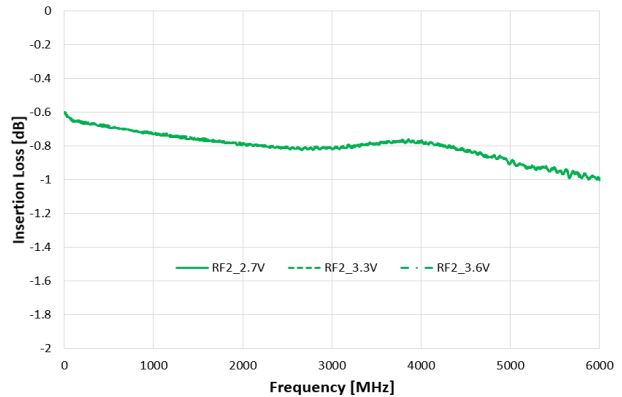

**Figure 6 Insertion Loss vs Temp (RFC - RF1)**

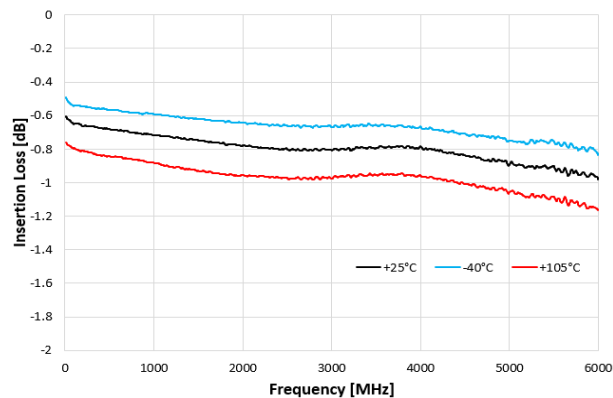

**Figure 7 Insertion Loss vs Temp (RFC - RF2)**

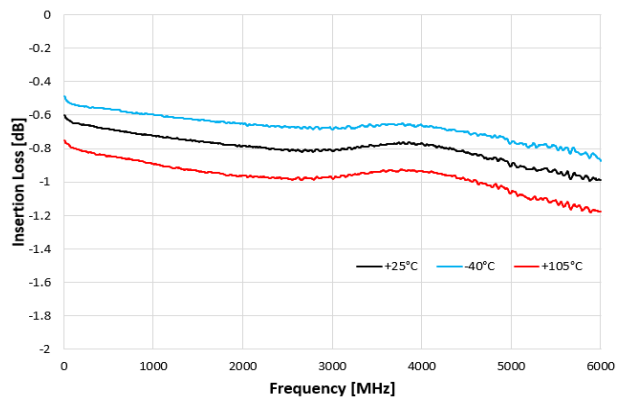

**Figure 8 Return Loss vs VDD (RFC, RFx) @ On State**

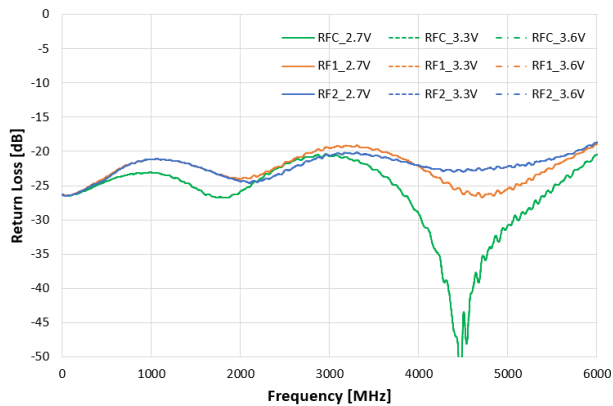

**Figure 9 Return Loss @RFC : RF1 ON vs RF2 ON**

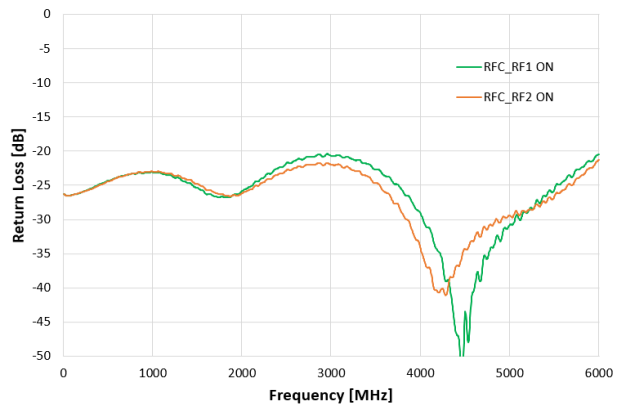

### Typical Performances

Typical conditions are at VDD = 3.3V, T<sub>A</sub> = 25°C, LS/CTRL Low = 0V, LS/CTRL High = 3.3V, Z<sub>L</sub> = 50Ω, Excluding SMA Connector and PCB loss, unless otherwise noted.

**Figure 10 Return Loss vs Temp (RFC)**

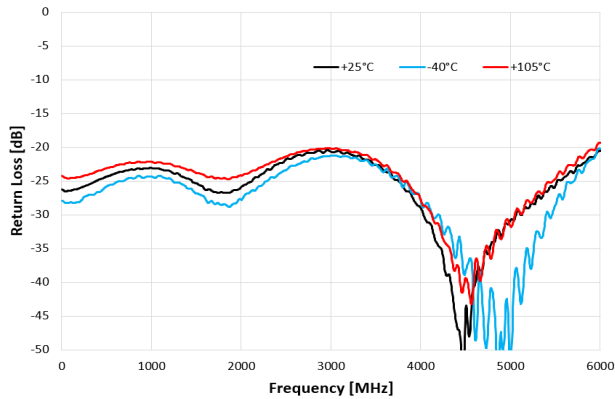

**Figure 11 Return Loss vs Temp (RF1, RF2)**

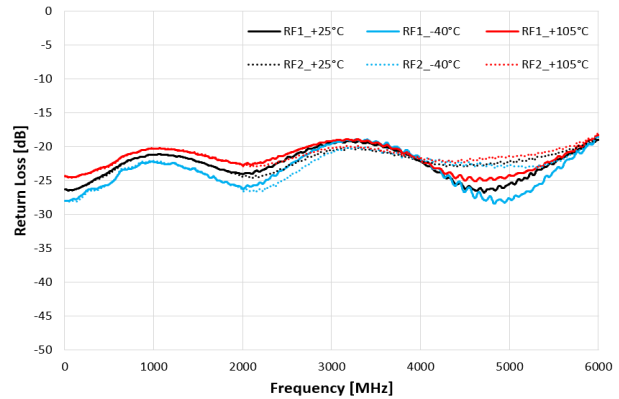

**Figure 12 Terminated Port Return Loss**

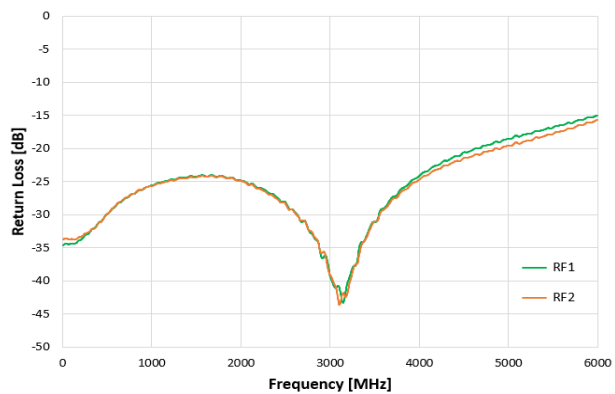

**Figure 13 Terminated Port Return Loss vs Temp (RF1)**

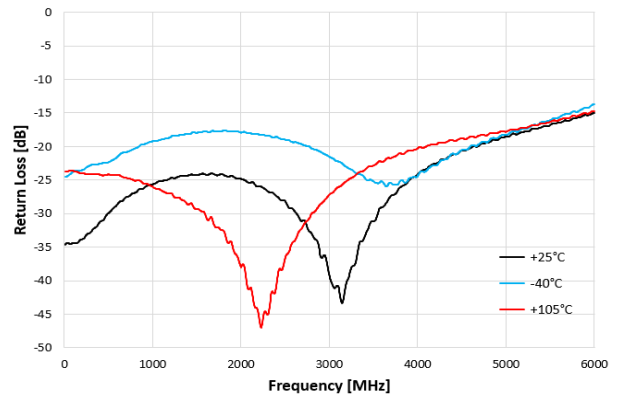

**Figure 14 Isolation vs VDD (RFC to RFx)**

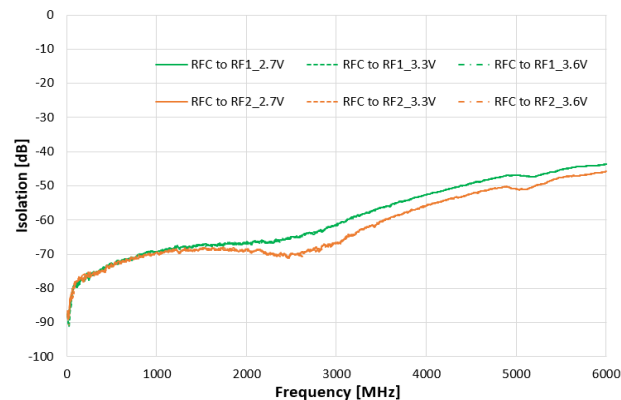

**Figure 15 Isolation vs Temp (RFC to RFx)**

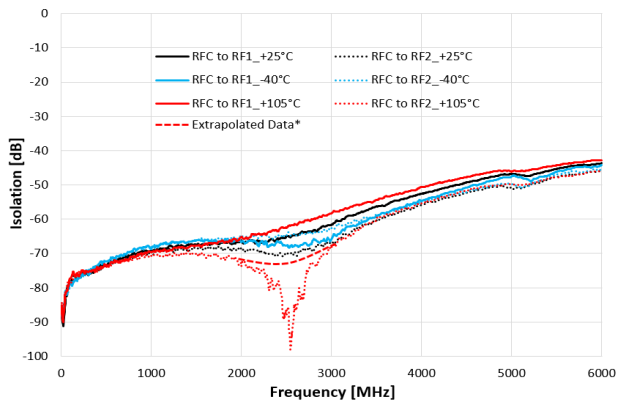

\* Extrapolated data is the actual performance of part excluding the resonance of the Evaluation board.

### Typical Performances

Typical conditions are at VDD = 3.3V, T<sub>A</sub> = 25°C, LS/CTRL Low = 0V, LS/CTRL High = 3.3V, Z<sub>L</sub> = 50Ω, Excluding SMA Connector and PCB loss, unless otherwise noted.

**Figure 16 Isolation vs VDD (RFx to RFx)**

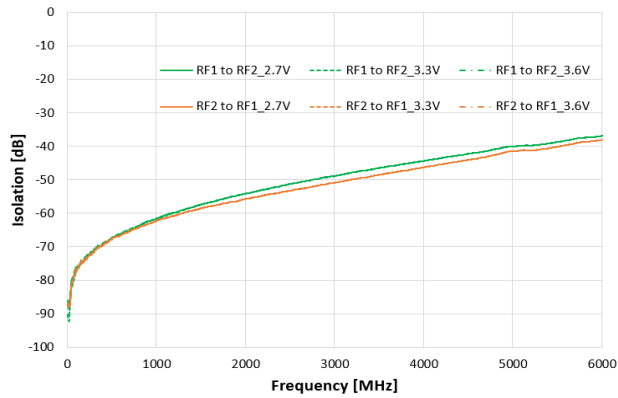

**Figure 17 Isolation vs Temp (RFx to RFx)**

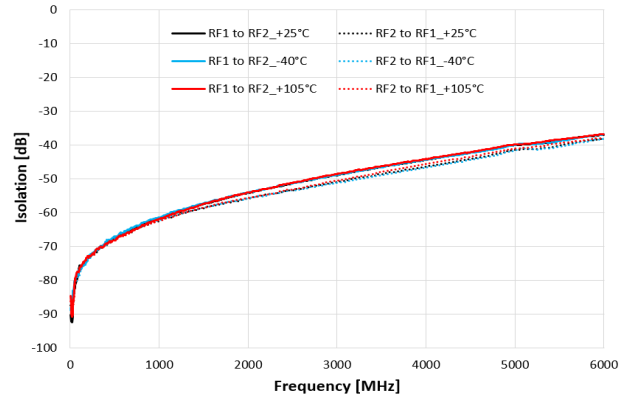

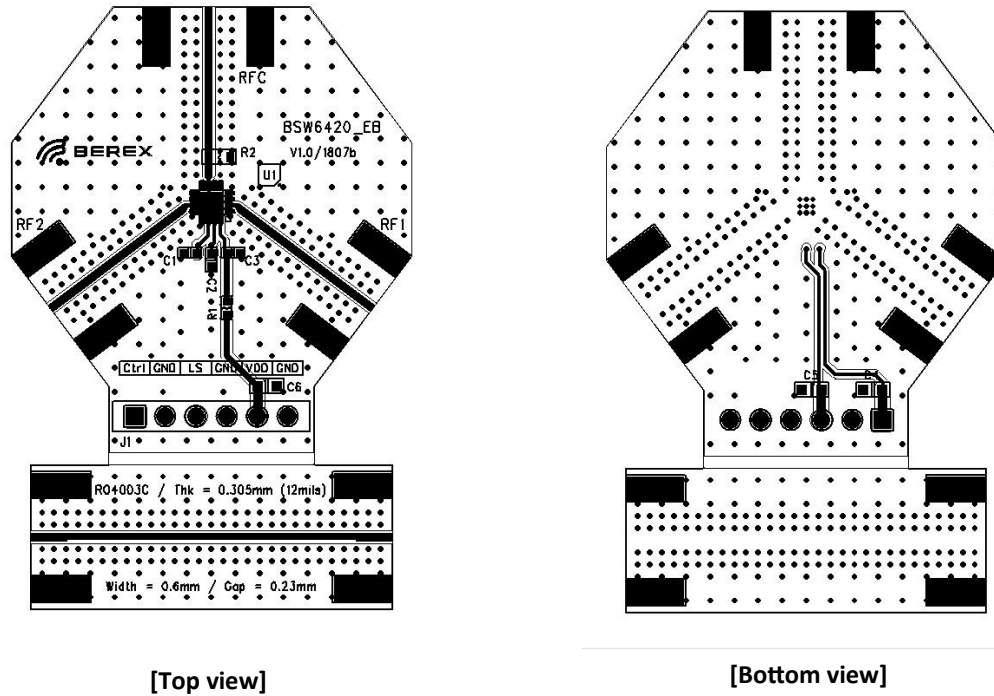
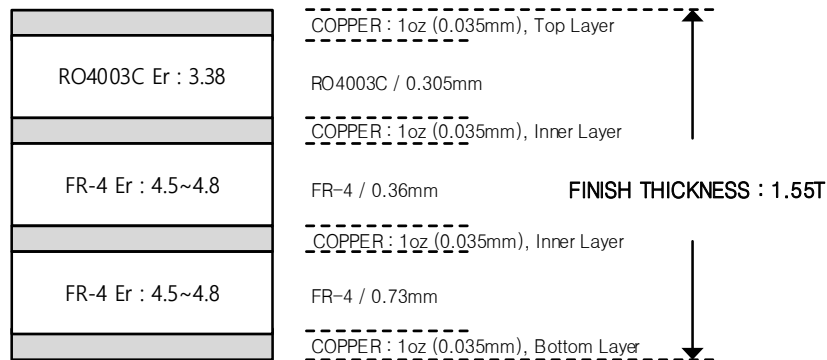
**Evaluation Board**

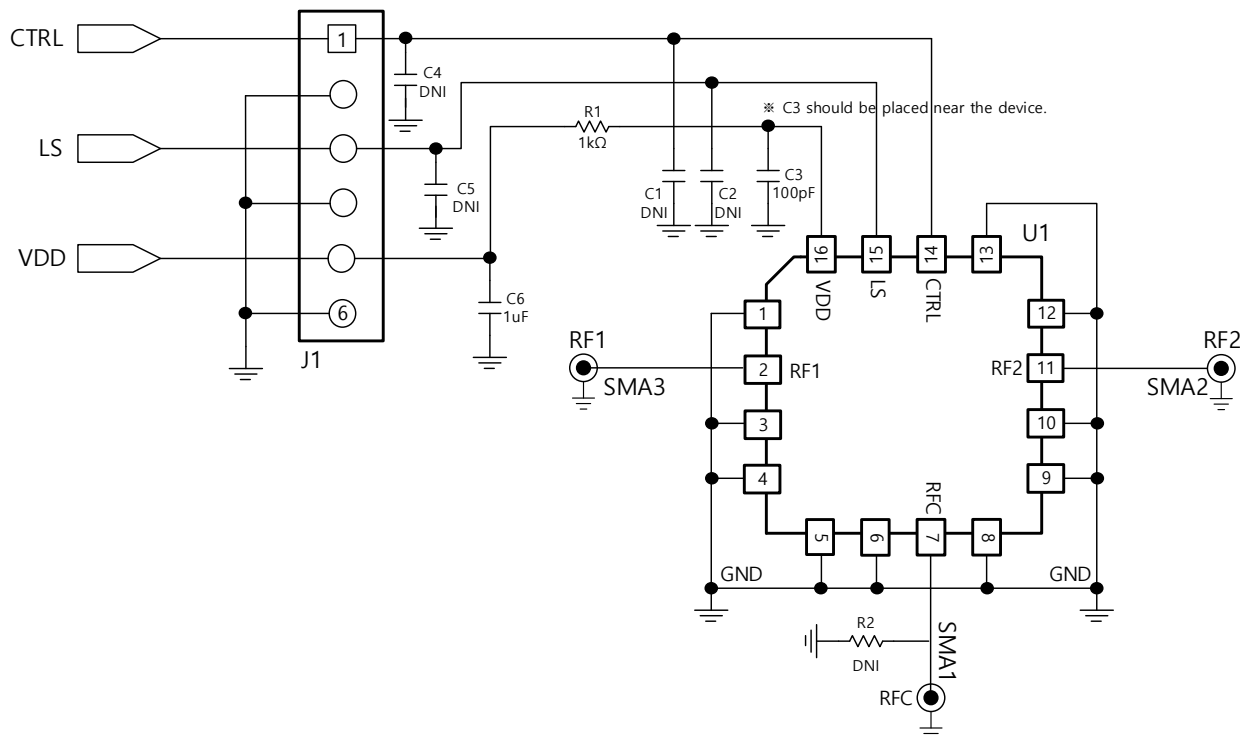
**Figure 18 Evaluation Board Layout**

**Figure 19 Evaluation Board PCB Layer Information**

**Figure 20 Evaluation Board Schematic**
**Table 6 Bill of Material - Evaluation Board**

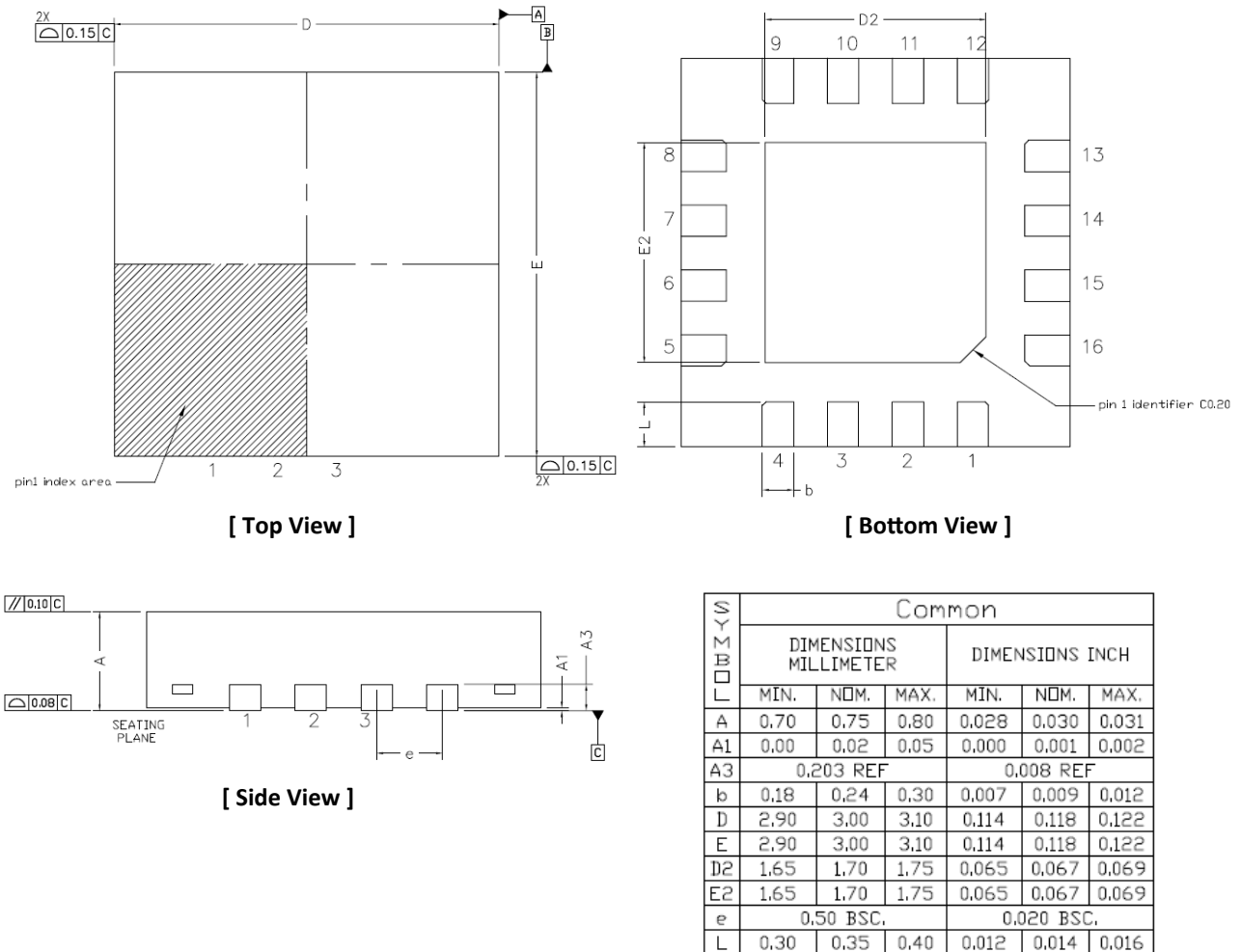
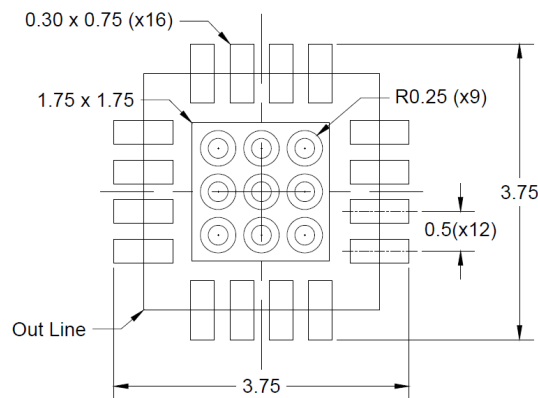
No.	Ref Des	Part Qty	Part Number	Remark
1	C3	1	CAP 1005 100pF J 50V	C3 should be placed rear the BSW6420
2	C6	1	CAP 1608 1uF J 50V	
3	R1	1	RES 1608 J 1Kohm	
4	C1, C2	2	CAP 1608 DNI	
5	R2	1	RES 1608 DNI	
6	C4, C5	2	CAP 1005 DNI	
7	J1	1	6 Pin Header	
8	RFC, RF1, RF2	3	SMA_END_LAUNCH	
9	U1	1	BSW6420	

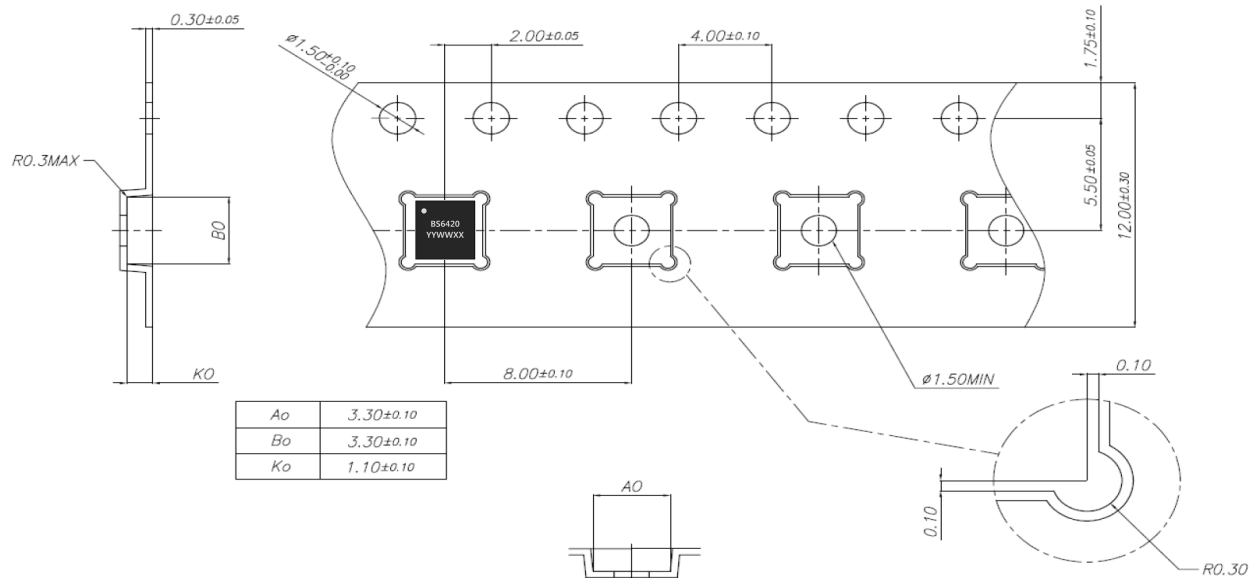

**Package Outline Drawing**

**Figure 21 Package Outline Drawing**

**Figure 22 Recommended Land Pattern**

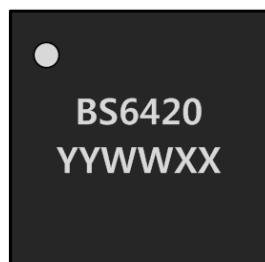
**Tape & Reel**

Packaging information:	
Tape Width	12mm
Reel Size	7inch
Device Cavity Pitch	8mm
Device Per Reel	1000EA

**Figure 23 Tape & Reel**
**Package Marking**

Marking information:	
BS	BeRex RF Switch
6420	The name of switch
YY	Year
WW	Work Week
XX	Wafer Lot Number

**Figure 24 Package Marking**

### Lead plating finish

#### 100% Tin Matte finish

(All BeRex products undergoes a 1 hour, 150 degree C, Anneal bake to eliminate thin whisker growth concerns.)

### MSL / ESD Rating

ESD information1 :	
Rating	Class 2 (2000V)
Test	Human Body Model (HBM)
Standard	JS-001-2017

ESD information2 :	
Rating	Class C3 (1000V)
Test	Charged Device Model (CDM)
Standard	JS-001-2017

MSL information:	
Rating	Level 1 at +260°C convection reflow
Standard	JEDEC Standard J-STD-020



Proper ESD procedures should be followed when handling the device.

### RoHS Compliance

This part is compliant with Restrictions on the use of certain Hazardous Substances in Electrical and Electronic Equipment (RoHS) Directive 2011/65/EU as amended by Directive 2015/863/EU.

This product also is compliant with a concentration of the Substances of Very High Concern (SVHC) candidate list which are contained in a quantity of less than 0.1%(w/w) in each components of a product and/or its packaging placed on the European Community market by the BeRex and Suppliers.

### NATO CAGE code:

2	N	9	6	F
---	---	---	---	---